

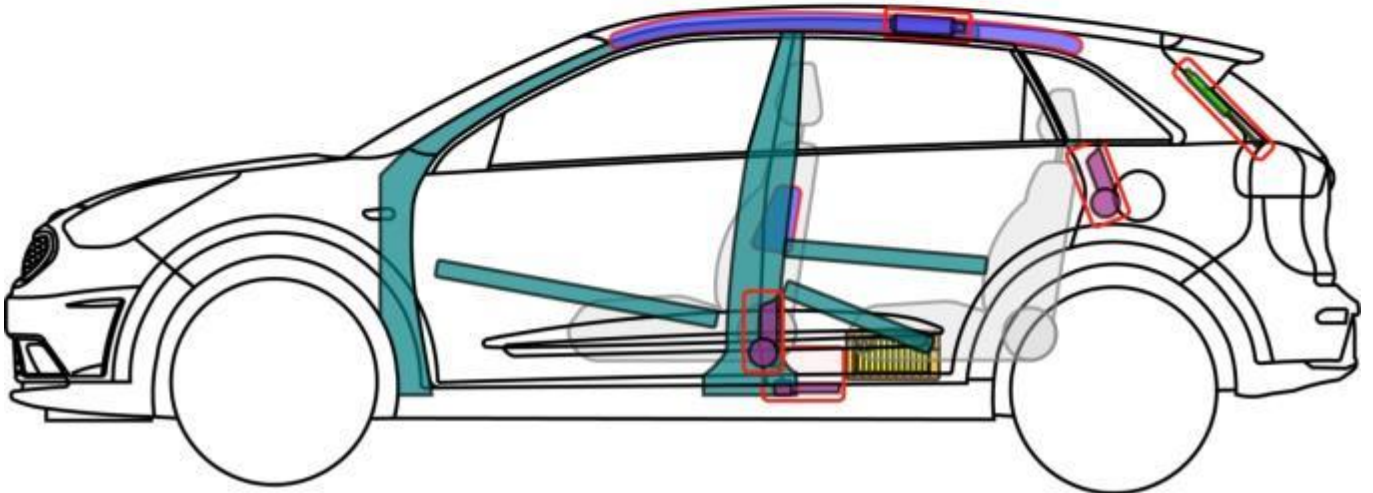

Niro (DE HEV)

from MY 2018-
12V in HV Battery

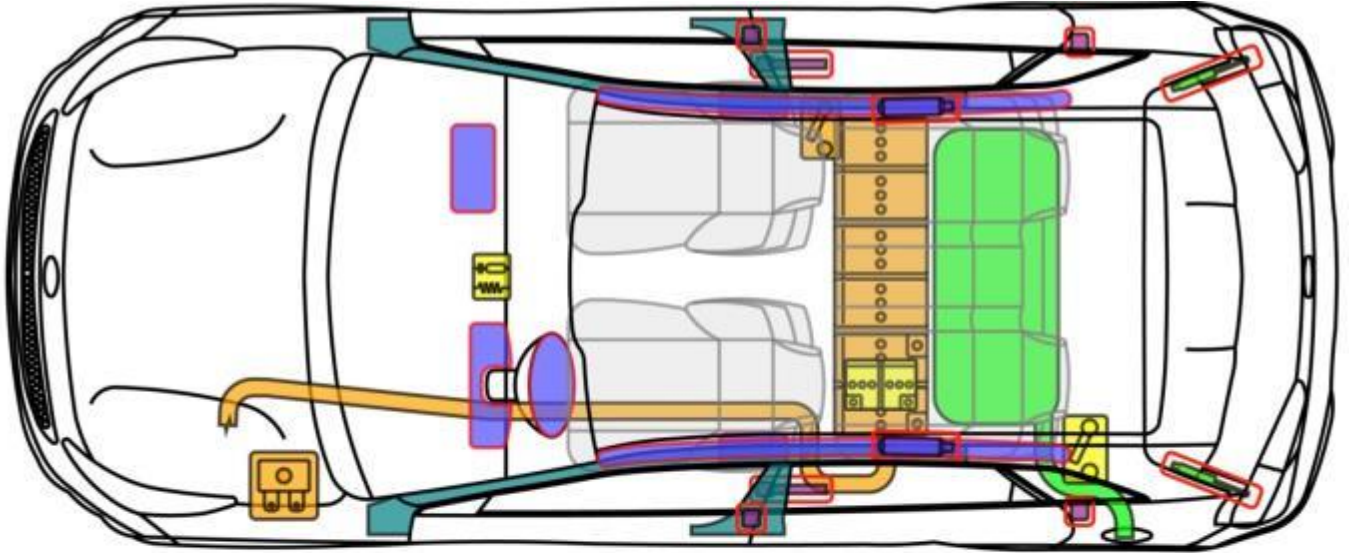

Legend

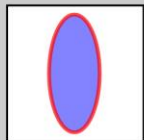

Airbag

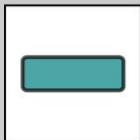

Reinforcement



SRS control unit

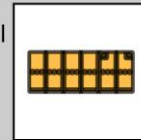

High voltage battery

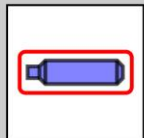

Stored gas inflator



Automatic roll bar

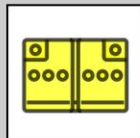

12 V Battery

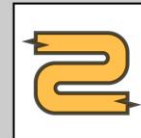

High voltage -cable/-component

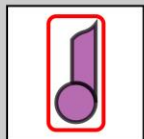

Seatbelt pretensioner

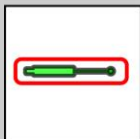

Cylinder

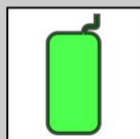

Fuel tank



High voltage emergency disconnect

Niro